

Application

Ideal for use where Lead-Free* valves are required. Designed for installation on potable water lines to protect against both backsiphonage and backpressure of polluted water into the water supply. Assembly shall provide protection where a potential health hazard does not exist.

Standards Compliance (Horizontal & Vertical)

- ASSE® Listed 1015
 - IAPMO® Listed
 - CSA® Certified B64.5
 - AWWA Compliant C510
 - Approved by the Foundation for Cross Connection Control and Hydraulic Research at the University of Southern California
 - UL® Classified (less shut-off valves only)
 - C-UL® Classified (less shut-off valves only)
 - Certified to NSF/ANSI 372* by IAPMO R&T
 - NSF® Listed-Standard 61, Annex G*
- *(0.25% MAX. WEIGHTED AVERAGE LEAD CONTENT)

Materials

Main valve body	Cast Bronze, ASTM B 584 (3/4-1")
Housing	Reinforced Nylon
Fasteners	Stainless Steel, 300 Series
Elastomers	Silicone (FDA Approved) Buna Nitrile (FDA Approved)
Internals	Delrin, NSF Listed
Springs	Stainless Steel, 300 series
Ball Valves	Cast Bronze, ASTM B 584
Struts	Forged Brass ASTM B 124

Features

Sizes:	3/4", 1", 1-1/4", 1-1/2", 2"
Maximum working water pressure	175 PSI
Maximum working water temperature	180°F
Hydrostatic test pressure	350 PSI
End connections	Threaded ANSI B1.20.1

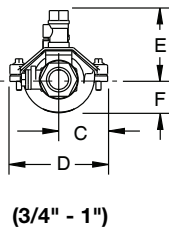
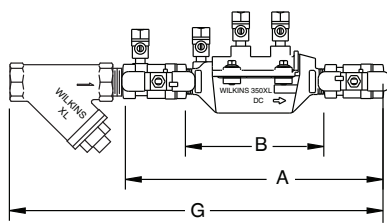

Options

(Suffixes can be combined)

- with full port QT ball valves (standard)
- L - less ball valves, male pipe thread
- S - with Model SXL lead-free bronze "Y" type strainer
- SH - with stainless steel handles
- FT - with integral male 45° flare SAE test fitting
- BOF - with blow out / flush fitting

Accessories

- Repair kit
- Thermal expansion tank (Model XT)
- QT-SET Quick Test Fitting Set
- Winterizing Blow out/Flush fitting (RK34-350BOF, RK1-350BOF or RK114-350-375BOF)

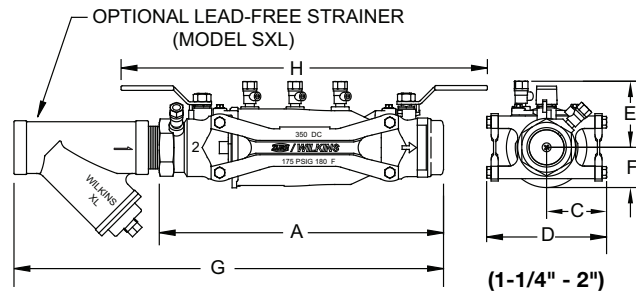

Dimensions & Weights (do not include pkg.)

MODEL 350 SIZE	DIMENSIONS (approximate)																WEIGHT				
	A		B LESS BALL VALVES		C		D		E		F		G		H		LESS BALL VALVES		WITH BALL VALVES		
	in.	mm	in.	mm	in.	mm	in.	mm	in.	mm	in.	mm	in.	mm	in.	mm	lbs.	kg	lbs.	kg	
3/4	20	11	279	6 5/8	168	1 7/8	48	3 3/4	95	3	76	1 1/4	32	15 1/8	384	11 7/16	291	2.3	1.0	4.3	2.0
1	25	12 1/4	311	7	178	2 1/16	52	4 1/8	105	3 1/4	83	1 3/4	45	17	431	12 5/16	313	3.0	1.4	6.0	2.7
1-1/4	32	14 7/8	378	14 3/8	367	3 3/8	86	6 3/4	171	3 3/4	95	2 1/4	57	20 1/2	521	18 1/2	470	17.2	7.8	19	8.6
1-1/2	40	15 1/4	387	14 3/8	367	3 3/8	86	6 3/4	171	3 3/4	95	2 1/4	57	22	559	20 1/4	514	17	7.7	20	9.1
2	50	16	406	14 3/8	367	3 3/8	86	6 3/4	171	3 3/4	95	2 1/4	57	24	609	20 3/4	527	18	8.2	22	10

MODEL 350XL 3/4" & 1" (STANDARD & METRIC)

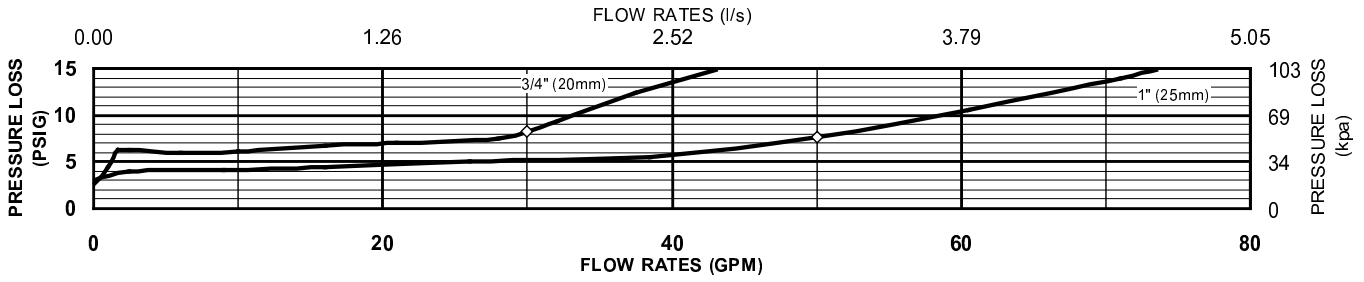

MODEL 350XL 1-1/4", 1-1/2" & 2" (STANDARD & METRIC)

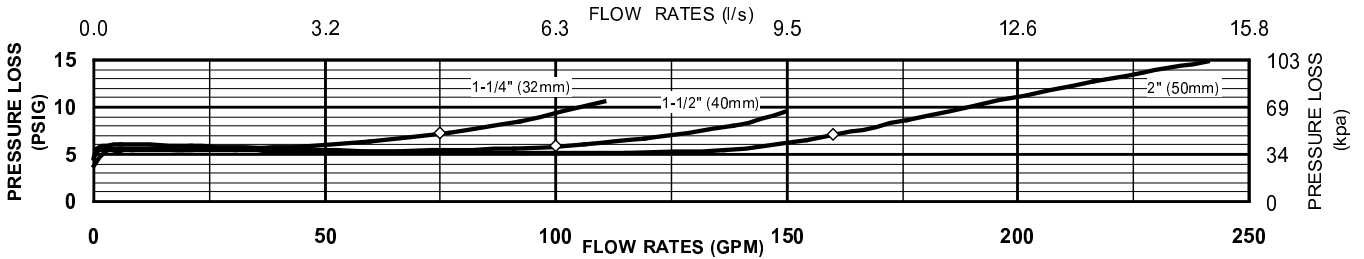

Typical Installation

Local codes shall govern installation requirements. To be installed in accordance with the manufacturers' instructions and the latest edition of the Uniform Plumbing Code. Unless otherwise specified, the assembly shall be mounted at a minimum of 12" (305mm) and a maximum of 30" (762mm) above adequate drains with sufficient side clearance for testing and maintenance. If installed below grade, be certain adequate drainage is provided to prevent the device from being submerged.

Capacity thru Schedule 40 Pipe				
Pipe size	5 ft/sec	7.5 ft/sec	10 ft/sec	15 ft/sec
1/2"	5	7	9	14
3/4"	8	12	17	25
1"	13	20	27	40
1 1/4"	23	35	47	70
1 1/2"	32	48	63	95
2"	52	78	105	167

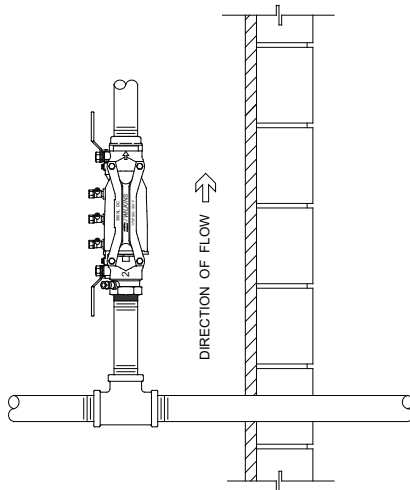

INDOOR INSTALLATION

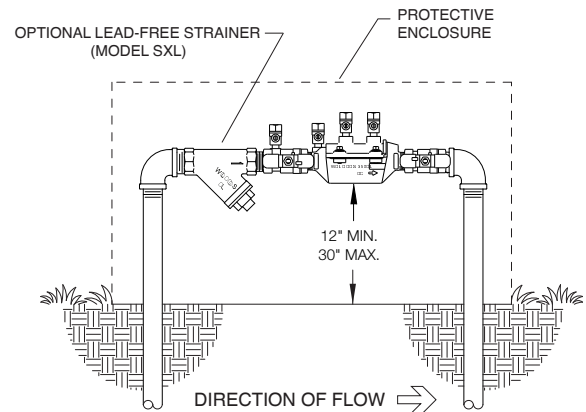

OUTDOOR INSTALLATION

Specifications

The Double Check Valve Backflow Preventer shall be certified to NSF/ANSI 372, shall be ASSE® Listed 1015, rated to 180°F, and supplied with full port ball valves. The main body shall be low lead Bronze for sizes 3/4" & 1", and Nylon for sizes 1-1/4" to 2". The housing shall be reinforced Nylon and the seat disc elastomers shall be silicone (FDA Approved). The first and second checks shall be accessible for maintenance without removing the device from the line. The Double Check Valve Backflow Preventer shall be a ZURN WILKINS Model 350XL.